



ITT

Electronic Components

Cannon 75 Ohm Connectors



Engineered for life

Cannon 75 Ohm Connectors

ITT Electronic Components is a division of the multi-national ITT Corporation a \$7.5 billion dollar global enterprise. Our extensive portfolio offers the most reliable and cost effective range of interconnect solutions. These innovations have enabled ITT to provide products and technologies to such markets as:

- Aerospace
- Broadcast
- Computers Systems
- Defense Electronics
- Geophysical
- Industrial Automation
- Medical Electronics
- Network Systems
- Telecom Switching
- Underwater Systems
- Wireless

Offering the broadest selections of standard and custom RF interconnects, ITT is the one stop source for design, development, manufacturing, and testing of sophisticated connectors.

High Performance 75 Ohm Connectors

This 75 ohm RF catalog incorporates the most commonly used connectors used in today's routing, switching and transmission equipment. These include the popular Type 43 (SMZ), 1.0/2.3, QT-BNC, and 1.6/5.6

connector families. In addition we have included a tooling section to simplify and ease the assembly our our connectors both in the factory and for field installations. ITT is an approved manufacturer to ISO 9001 and ISO 14001 with locations worldwide to serve our customers.

The Custom Difference

ITT's world class engineering teams will work directly with our customers to design and develop cost effective solutions for their applications . In

many cases we may modify one of our standard designs to ensure a highly reliable solution where timing is critical. Yet, in those cases where a complete custom interconnect solution is required, ITT will work with our customer's Engineers to design an interconnect solution which will be cost effective yet highly reliable.



In addition to custom connectors, ITT offers sophisticated custom cable assembly capabilities for a wide range of applications. Our in house expertise translates to our ability to integrate different technologies within a custom cable harness.

Quick Reference Selection Guide

	QT BNC	Type 43 (SMZ)	1.0/2.3, Type 54	1.6/5.6
				
Frequency Range	0 to 2 GHz	0 to 3 GHz	0 to 2 GHz	0 to 1 GHz
Impedance	75 ohm nominal	75 ohm nominal	75 ohm nominal	75 ohm nominal
Operating Temperature	-40°C - 85°C 40°C - 185°C	-40°C - 85°C 40°C - 185°C	-40°C - 85°C 40°C - 185°C	-40°C - 85°C 40°C - 185°C
Mating Cycles	500 min	250 min	500 min	500 min
Mating Method / Coupling	Bayonet / Latch	Snap-on with posilock latch	Snap-on with push-pull latch	Snap-on with screwlock latch
Cable Termination	QT* Quick Termination	Crimp/Solder/ QT* Quick Termination	Crimp/Solder	Crimp/Solder
Cable Type	Flexible	Flexible	Flexible	Flexible
Body Material	Phosphor Bronze	Brass or Zamak	Brass or Zamak	Brass
Body Finish	Nickel	Nickel or Gold	Nickel or Gold	Nickel or Gold
Packaging: P/N ending with last digit "A"	see page 18	25 pieces per tray	25 pieces per tray	25 pieces per tray
Page Number	17	5	12	19



Dimensions shown in mm (inch)
Specifications and dimensions subject to change

www.ittcannon.com

Table of Contents

Type 43 (SMZ)	page 5
1.0/2.3	page 12
Balun	page 16
QT-BNC	page 17
1.6/5.6	page 19
Tooling	page 22

New electrical SFP transceiver for STM-1e applications from ITT



Designed to comply with the Small Form Factor Pluggable (SFP) industry-standard multi source agreement (MSA), the new Cannon SFP-155E™ electrical transceiver from ITT delivers full duplex STM-1 electrical (155 Mbit/s) SDH transport over coaxial cables and are fully interchangeable with STM-1 optical SFP's. Any system that already supports STM-1 optical can now support STM-1 electrical by using the SFP-155E. More importantly a single circuit card can now support both optical and electrical STM-1 interfaces, reducing system capital and operating costs. The electrical interface is fully compliant with telecom ITU-T G.703 (ES1) recommendations and can be connected using standard DIN 1.0/2.3 75 ohm cable connectors. The SFP-155E enables systems designers to reduce time-to-market at a lower cost, and with full flexibility. Serial identification (EEPROM) in accordance with the SFP MSA is available. Typical applications include Next Generation SDH Add/Drop multiplexers, Optical Edge Devices, MSPP and Switching Systems.

Contact Customer Service for more information on this product.

Connector/Cable Selection Guide

Given here are details of all popular cables with which the connectors in this publication may be used.

Cable numbers suitable for use with all cable mounting connectors are given opposite the connector part numbers in the series chose.

If the connector style is not shown against your selected cable, please contact Customer Service.

Cable Number	Impedance (ohms)	Diameter of Jacket	Diameter of Outer Conductor (Max)	Diameter of Dielectric (Max)	Diameter of Center Conductor (Nom)
BT2002*	75	5,30 (.209)	3,81 (.150)	2,45 (.096)	0,60 (.024)
BT2003*	75	6,90 (.272)	5,06 (.199)	3,70 (.146)	0,61 (.024)
BT3002*	75	3,55 (.140)	2,85 (.112)	1,95 (.077)	0,31 (.012)
M17/29-RG59	75	6,27 (.247)	4,85 (.191)	3,81 (.150)	0,56 (.022)
RD179*	75	3,07 (.121)	2,69 (.106)	1,68 (.066)	0,30 (.012)
RG59/U	75	6,25 (.246)	4,85 (.191)	3,81 (.150)	0,58 (.023)
RG179/U	75	2,67 (.105)	2,13 (.084)	1,68 (.066)	0,30 (.012)
TZC75024*	75	3,55 (.140)	3,01 (.119)	1,95 (.077)	0,31 (.012)
1694A*	75	6,99 (.275)	5,44 (.214)	4,57 (.180)	1,02 (.040)
734*	75	6,10 (.240)	5,21 (.205)	3,89 (.153)	0,79 (.031)
735A*	75	3,51 (.138)	2,79 (.110)	2,01 (.079)	0,41 (.016)
0.25/1.3* (mini coax)	75	2,10 (.083)	1,65 (.065)	1,35 (.053)	0,25 (.010)
RA7000*	75	4,50 (.177)	3,40 (.134)	2,80 (.110)	0,60 (.024)
RA8000*	75	2,75 (.108)	1,95 (.077)	1,45 (.057)	0,31 (.012)
1855A *	75	4,04 (.159)	3,51 (.138)	2,59 (.102)	0,58 (.023)

* Double shielded

Dimensions shown in mm (inch)
Specifications and dimensions subject to change

www.ittcannon.com



Cannon 75 Ohm Connectors

QT Quick Termination

The QT (Quick Termination) 75 ohm connector series was designed to meet the rigorous specifications of the telephony, broadcast and data communications industry. With only two components to handle, our QT connectors are easier to terminate than the current industry standard products while providing reliable electrical and mechanical performance.



QT connectors were first installed on 140Mbit lines in an international telecommunications exchange over 15 years ago, and since that day ITT have supplied over 30 million QT connectors into many of the world's leading networks.

- QT=** 'Quick Termination' of coaxial connectors
- QT=** 3:1 reduction in assembly time
- QT=** No crimping or soldering of the center contact
- QT=** No special tooling required
- QT=** Simplified assembly
- QT=** Fewer wasted parts
- QT=** Reduced tooling maintenance and calibration
- QT=** Pre-assembled center contact
- QT=** A reliable, high pressure, gas tight joint

Several innovative concepts and technologies are used in our QT designs. The primary technological feature is a captivated center pin that provides a high pressure gas tight joint of exceptional mechanical and electrical integrity on solid center conductors; termination is achieved without crimping or soldering to the cable's center conductor. The cable center conductor is terminated to the inner contact within the connector assembly by activating the QT (patented) mechanism using the simple plastic tool provided. Connectors referenced in this catalog with "QT" have this technology.

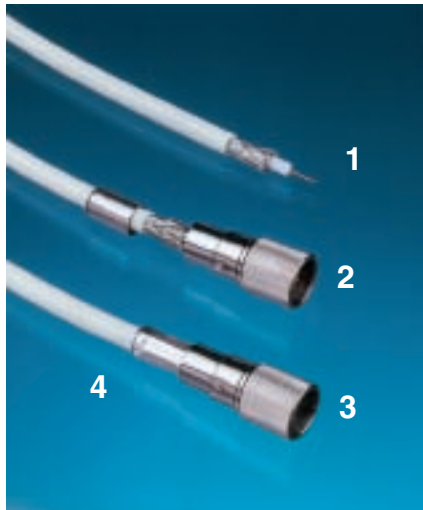

The assembly is completed in 4 simple steps:

- STEP 1:** Strip cable
- STEP 2:** Assemble connector onto cable
- STEP 3:** Press insulator into the body using the plastic tool provided
- STEP 4:** Crimp the ferrule using a standard crimp tool

For high volume terminations, some styles can also be assembled using dedicated hand or pneumatic bench tooling.

QT connectors provide large productivity savings, high quality and premium performances... all at a competitive price.



Dimensions shown in mm (inch)
Specifications and dimensions subject to change

www.ittcannon.com

Type 43 (SMZ)

ITT's wide range of Cannon Type 43 / SMZ connectors are extensively used in 75 ohm communication systems and have become the recognized standard in telecommunications in many parts of the world.

Designed around the requirements of BS9210 F0022 and draft specifications CECC 122 300, these connectors are designed for field installation and feature the 'Posi-Lock' latch to prevent accidental disconnection.

A special feature of the Cannon Type 43 / SMZ range is the QT (Quick Termination) technology for cable connectors. Designed to reduce assembly time and loose parts, the QT termination system incorporates a connector body with a pre-assembled center contact, termination is simple with no loose contact to drop or lose. QT provides a reliable gas tight connection between the inner conductor of the cable and connector contact that meets the most stringent industry standards. For PCB connectors a snap fit feature is incorporated into certain styles to hold the connector in position during soldering.



Choice of Two Latching Styles – Standard or HDC (High Density)

ITT's Cannon Type 43 / SMZ connectors are available in 2 package sizes, Standard and HDC (High Density). Whilst both configurations have the same interface dimensions and are intermateable, the outer body size of HDC is reduced to facilitate a closer packing density on the equipment or distribution frame.

Applications

- Switching Equipment • DSX Cross Connects • Base Stations • Routers • Wireless • Telecom • LAN Equipment

Features and Benefits

High performance gold plated contact areas ensure reliable long term operation

Posi-Lock locking mechanisms ensure secure coupling and ease of engagement and separation

Designed for the most commonly used telecom cables in North America and Europe

Designed for robust and reliable field installation

Available for BT standard and HDC distribution frames

Three-part construction with crimp inner contact and outer ferrule (no soldering required)

PCB Plugs come with offset legs for board locking

QT (Quick termination) technology available for most cable types

Product offering includes U-links and between series adaptors

True 75 ohm characteristic impedance up to 3 GHz (for selected styles)

Most designs require no special tooling

"Teplock" mounting reduces the time needed for fitting to DDF's

RoHS compliant part numbers



Cannon 75 Ohm Connectors

Type 43 (SMZ)

Specifications

ELECTRICAL	Impedance	75 Ω nominal	
	Frequency Range	0 to 3.0 GHz (some styles limited to 1.0GHz)	
	Working Voltage (dc or ac peak)	At sea level, inner conductor to shell = 500 V	
	Proof Voltage (dc or ac peak)	At sea level = 1500 V	
	Insulation Resistance	5 G Ω minimum	
	Contact Resistance*	Center contact: 5.0m Ω maximum. Outer contact: 1.0m Ω maximum	
	Reflection Coefficient	Refer to CECC122300	
	Current Rating	1.5 A dc maximum	
	MECHANICAL	Engagement Forces	All snap-on, Screw-Lock & Posi-Lock styles except U Links = 60 N (13.5 lbs.) maximum U Links (reduced force snap-on) = 40 N (9 lbs.) maximum
		Separation Forces	All snap-on, Screw-Lock & Posi-Lock styles except U Links = 60 N (13.5 lbs.) max, 8 N (1.8 lbs.) min. U Links (reduced force snap-on) = 40 N (9 lbs.) maximum, 20 N (4.5 lbs.) minimum
Posi-Lock Latch withstand Pull		220 N (50 lbs.)	
Contact and Insulator Retention		21 N (4.7 lbs.)	
Materials		Body components: Copper or zinc alloy. Center contacts (male/female): Copper alloy. Insulators: PTFE or thermoset plastic. Crimp ferrules: Annealed copper alloy	
ENVIRONMENTAL	Finish/Plating	Center contacts: Gold. Outer contacts: Gold. Other metal parts: Nickel, tin or zinc	
	Vibration Severity	(a) Frequency range: 10 Hz to 500 Hz. (b) Displacement**: 0,75 (.029). (c) Acceleration**: 98 m/s ² (321 ft./s ²). (d) Duration: 6 hours. ** Cross over at approx. 60 Hz	
	Shock Severity	490 m/s ² for 11 ms	
	Impact Severity (free specimens only)	5 impacts at 1m	
	Climatic Category	40/100/21	
GENERAL	Bump	4000 total at 390 m/s ²	
	Free Fall (U Link only)	BS2011: Part 2.1 Ed. Procedure 2. Severity: 50 falls	
	Connector Durability	250 matings minimum	

*Except U Link connectors. See BS9210 F0022 for details.

NOTES

¹⁾ Values in this specification are typical for this range. Specific connectors may vary.

²⁾ Cannon 75 ohm coaxial connectors are designed to meet or exceed the requirements of BS9210F0022 where applicable. This specification may be superseded by CECC122 300 and the details listed above are subject to change without notice to comply with changes in these specifications.

Mating Interfaces

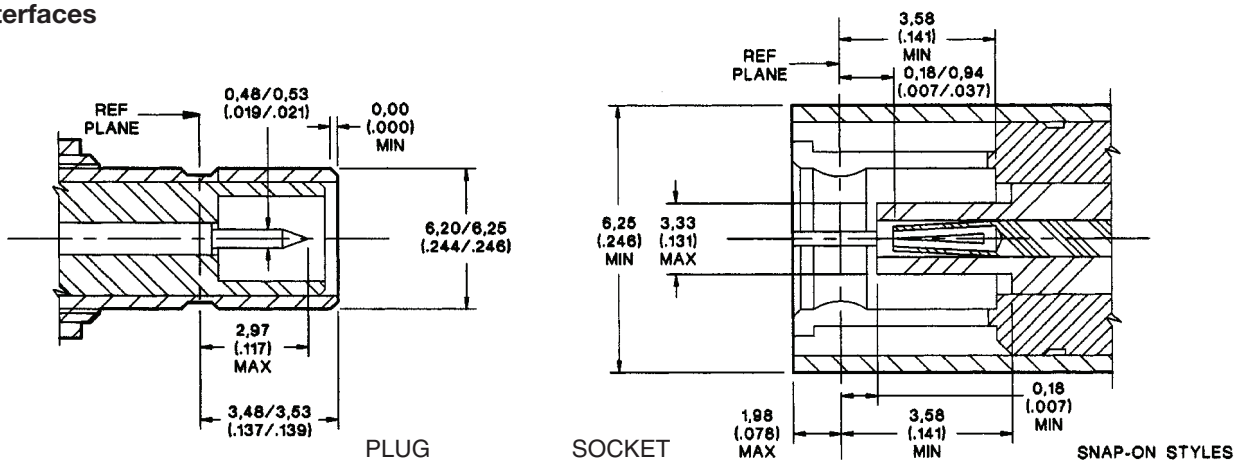

Please note that the description of the 2 halves follow the UK telecom format. In other regions a plug may be called a jack, and a socket may be called a plug. Please take care when choosing your connectors.



Dimensions shown in mm (inch)
Specifications and dimensions subject to change

www.ittcannon.com

Cannon 75 Ohm Connectors

Type 43 (SMZ)

DDF Crimp Plug

Part Number	Cable Type	Industry Reference
051-127-9739A9A	BT2001	P43/1GTIS
051-127-9749A9A	BT2002	P43/2GTIS
051-127-9759A9A	BT2003	P43/3GTIS
051-127-9769A9A	BT3002 / TZC75024	P43/5GTIS
051-127-9479A9A	RA7000	P43/7GTIS
051-127-9779A9A	RG179B/U	P43/4GTIS

Assembly Instructions: BBAI 1265

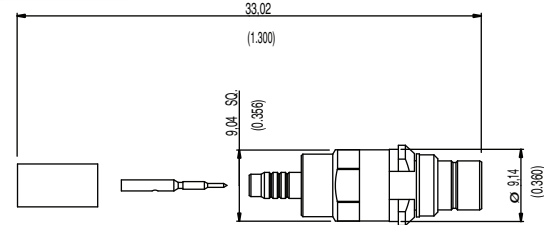

DDF QT Plug

Part Number	Cable Type	Industry Reference
W51-127-9439A9A	BT2003	BT43/3GTIQT
W51-127-9459A9A	BT3002 / TZC75024	BT43/5GTIQT
W51-127-9479A9A	RA7000	
W51-127-9059A9A	RA8000	
W51-127-9289A9A	NCX	
W51-127-9049A9A	735A	
W51-127-9369A9A	ST212 / CT1320/735A (alt)	
W51-127-9789A9A	RG59B	
W51-127-9039A9A	2.5C-2V	
W51-127-9119A9A	0.25/1.3 (mini coax)	

Assembly Instructions: BBAI 1238

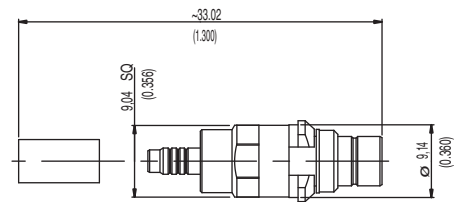

Posilock Straight Crimp Socket

Part Number	Cable Type	Industry Reference
051-124-977991A	BT2002	S43/2FS
051-124-978991A	BT2003	S43/3FS
051-124-979991A	BT3002 / TZC75024	S43/5FS
051-124-983991A	RG179B/U	S43/4FS
051-124-950991A	2.5C-2V	
051-124-943991A	ST212/CT1320/735A	

Assembly Instructions: BBAI 1265

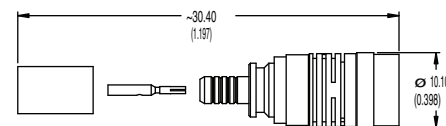

Posilock Straight QT Socket

Part Number	Cable Type	Industry Reference
W51-124-953991A	BT2003	S43/3FQT
W51-124-963991A	BT3002/TZC75024	S43/5FQT
W51-124-960991A	RA7000	S43/7FQT
W51-124-947991A	RA8000	S43/8FQT
W51-124-996991A	735A	
W51-124-944991A	NCX	
W51-124-943991A	ST212 / CT1320/735A (alt)	
W51-124-966991A	RG59U	
W51-124-950991A	2.5C-2V	
W51-124-999991A	0.25/1.3 (mini coax)	

Assembly Instructions: BBAI 1238

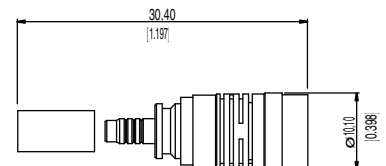

Dimensions shown in mm (inch)

Specifications and dimensions subject to change

Contact Customer Service for other cable types



Cannon 75 Ohm Connectors

Type 43 (SMZ)

Posilock Right Angle Socket

Part Number	Cable Type	Industry Reference
051-128-922991A	BT2002	S43/2C
051-128-923991A	BT2003	S43/3C
051-128-924991A	RG179B/U	S43/4C
051-128-933991A	BT3002/TZC75024	S43/5C
051-128-947991A	RA7000	S43/7C
051-128-941991A	RG59U	
051-128-935991A	735A	

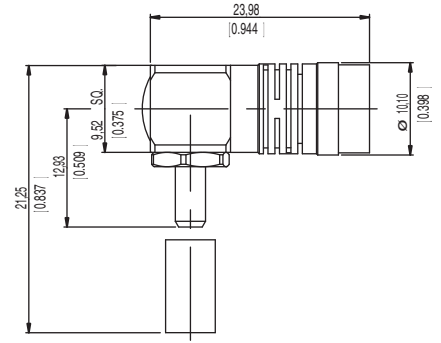

Assembly Instructions: BBAI 1041

Contact Customer Service for other cable types

Coaxial U Links

Part Number	Industry Reference
055-181-9079AZ0	Link 13A (without monitor port)

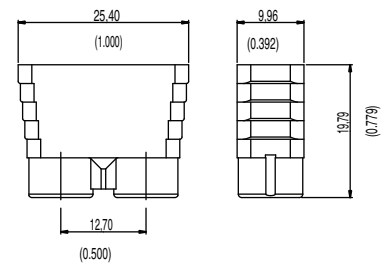

055-181-9119AZ0	Link 13B (with -30dB monitor port)
-----------------	------------------------------------

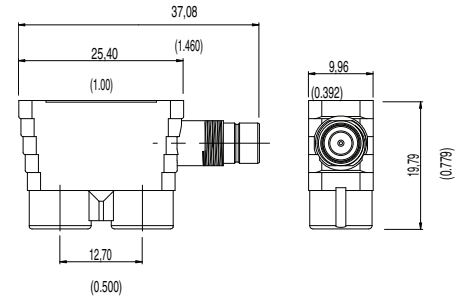

Straight PCB Plug

Part Number
051-151-9019A9A

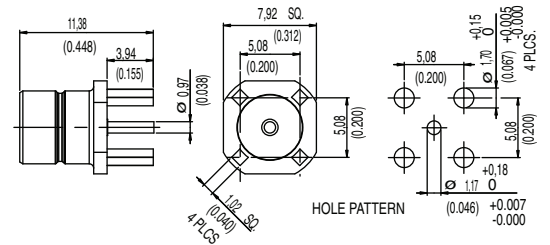

Dimensions shown in mm (inch)
Specifications and dimensions subject to change

www.ittcannon.com

Type 43 (SMZ)

Straight Screw-lock PCB Plug

Part Number
051-151-9029A9A

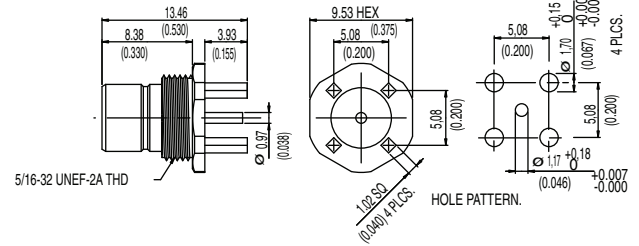

Straight Bulkhead PCB Plug

Part Number
051-151-9079A9A

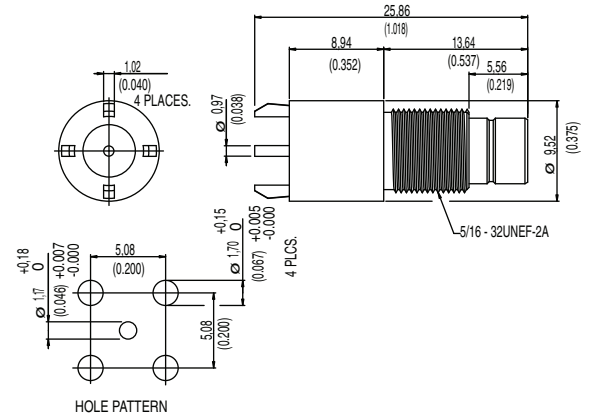

A0023384 Panel Mounting Hardware kit
(Washer and Lock Nut)

Right Angle PCB Plug

Part Number
051-153-9089A9A Plug 43/1E

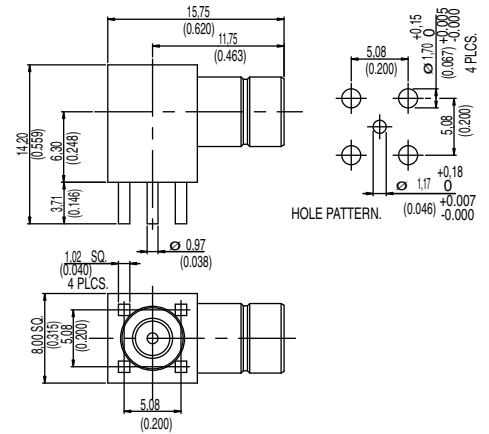

Right Angle Bulkhead PCB Plug with board retaining legs

Part Number
051-153-9119EAA



B0023382 Panel Mounting Hardware Kit
(Spacer, Washer, Lock Washer, Lock Nut)

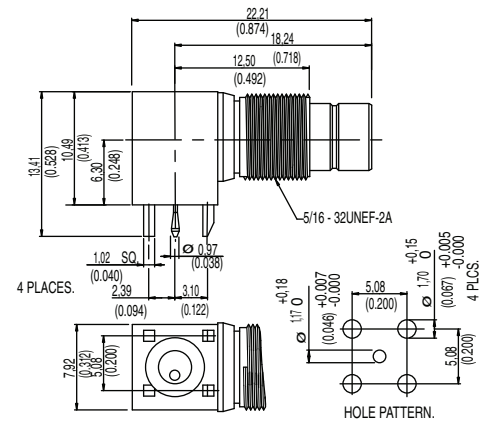

Dimensions shown in mm (inch)
Specifications and dimensions subject to change

www.ittcannon.com



Cannon 75 Ohm Connectors

HDC 43 (SMZ)

HDC43 DDF Crimp Plug

Part Number	Cable Type	Industry Reference
051-127-9849A9A	BT2002	HDC43/2GTIS
051-127-9859A9A	BT2003	HDC43/3GTIS
051-127-9879A9A	RG179B/U	HDC43/4GTIS
051-127-9869A9A	BT3002/TZC75024	HDC43/5GTIS
051-127-9609A9A	RA7000	HDC43/7GTIS

Assembly Instructions: BBAI 1265

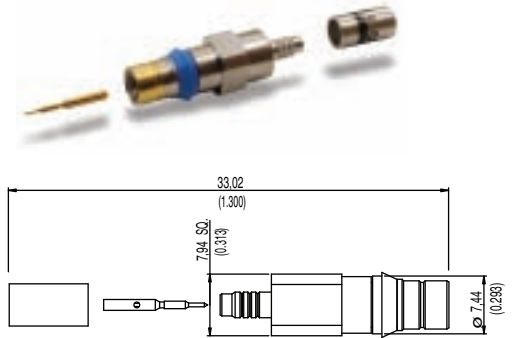

HDC43 DDF QT Plug

Part Number	Cable Type	Industry Reference
W51-127-9929A9A	BT2003	HDC43/3GTIQT
W51-127-9909A9A	BT3002 / TZC75024	HDC43/5GTIQT
W51-127-9609A9A	RA7000	HDC43/7GTIQT
W51-127-9069A9A	RA8000	HDC43/8GTIQT
W51-127-9019A9A	NCX	
W51-127-9029A9A	735A	
W51-127-9379A9A	ST212 / CT1320/735A (alt)	
W51-127-9109A9A	0.25/1.3 (mini coax)	

Assembly Instructions: BBAI 1238

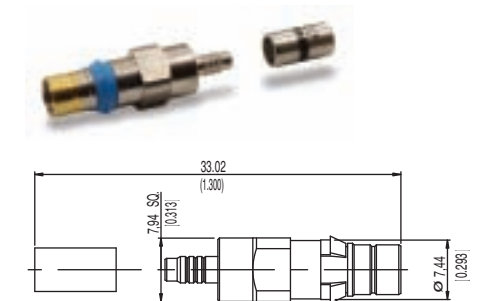

HDC Posilock Straight Crimp Socket

Part Number	Cable Type	Industry Reference
051-124-937991A	BT3002/TZC75024	HDC43/5FS
051-124-929991A	RA7000	HDC43/7FS
051-124-984991A	RG179B/U	HDC43/4FS
051-124-9489C9A	ST212 / CT1320/735A	nickel plated outer contact
051-124-9849C9A	RG179B/U	nickel plated outer contact
051-124-9859C9A	RD179	nickel plated outer contact

Assembly Instructions: BBAI 1265

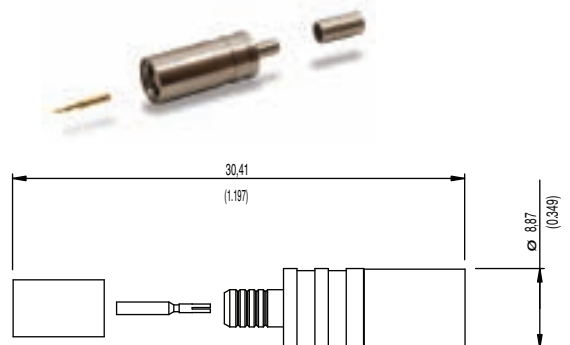

HDC Posilock Straight QT Socket

Part Number	Cable Type	Industry Reference
W51-124-937991A	BT3002/TZC75024	HDC43/5FQT
W51-124-929991A	RA7000	HDC43/7FQT
W51-124-9489C9A	ST212 / CT1320 / 735A	nickel plated outer contact

Assembly Instructions: BBAI 1238

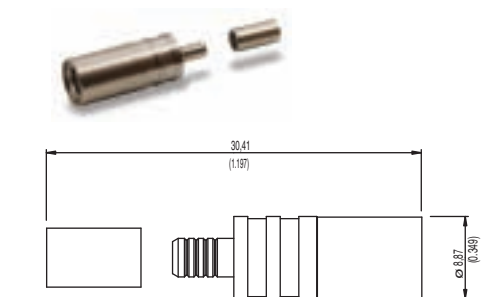

Contact Customer Service for other cable types



Dimensions shown in mm (inch)
Specifications and dimensions subject to change

www.ittcannon.com

Cannon 75 Ohm Connectors

HDC 43 (SMZ)

HDC Coaxial U Links

Part Number

Industry Reference

055-181-9129AZ0

HDC Link 10A (without monitor port)

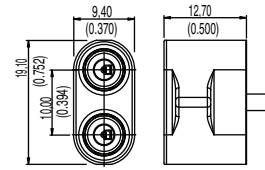

055-181-9139AZ0

HDC Link 10B (with -30dB monitor port)

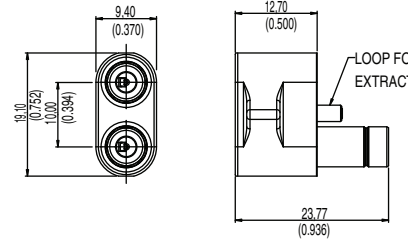

Dimensions shown in mm (inch)
Specifications and dimensions subject to change

www.ittcannon.com



Cannon 75 Ohm Connectors

1.0/2.3

The Cannon 75 ohm 1.0/2.3 connector series are widely used in applications requiring a high density solution and have become a standard in telecommunications in many parts of the world.

Designed to meet the requirements of DIN 47247 and CECC 22230, these connectors feature a push/pull coupling mechanism to ensure mating integrity and a snap-on interface for ease of connection. Due to their small size these connectors can be densely packed while providing significant space savings over other 75 ohm connector products.

In addition, we offer the Type 54 version of the 1.0/2.3 connector which meets the requirements of BT RC9333. The Type 54 connector combines the 1.0/2.3 interface and push-pull locking system with the termination methods and tooling benefits of the Type 43 (SMZ) connector.

Our newest product offering for this connector series is the 1.0/2.3 HD (High Density) connector. By re-engineering the latching mechanism we were able to successfully reduce the size of the connector by 20% allowing even greater density than the standard 1.0/2.3 plug.



Choice of 3 styles – Standard, High Density or Type 54



Applications

- Switching Equipment
- DSX Cross Connects
- Base Stations
- Routers
- Wireless
- Telecom
- LAN Equipment

Features and Benefits

Push-pull locking mechanism for secure coupling and ease of engagement and separation

Designed for the most commonly used cables in North America and Europe

New High Density version with 6.2mm outside diameter

Three-part construction with crimp inner contact and outer ferrule (no soldering required)

Ideal for applications requiring a high density solution (space savings)

Uses industry standard crimp tooling

Available in a Type 54 configuration

Cable connectors designed for field installation

High performance gold plated contact area ensures reliable long term operation



Dimensions shown in mm (inch)
Specifications and dimensions subject to change

www.ittcannon.com

Cannon 75 Ohm Connectors

1.0/2.3

Mating Interfaces

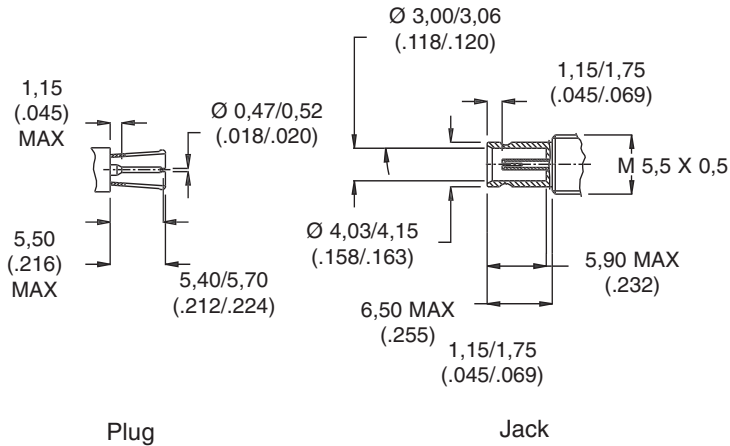

Electrical

Impedance	75Ω nominal
Frequency Range	With 75 Ω connector on 75 Ω cable = 0 - 2 Ghz
Voltage Rating	At Sea level = 250 Vrms
Insulation Resistance	1000 MΩ minimum
Contact Resistance	Inner contact = 6mΩ typical/ maximum Outer contact = 2.5mΩ maximum
	With 75 Ω connector on 75 Ω cable and f = 1 Ghz = 0.1 maximum

Mechanical

Withdrawal Force, inner female contact	0.2 N (0.04 lbs.) minimum
Withdrawal force, outer male contact	0.7 N (0.15 lbs.) minimum
Insertion force between jacks and plugs	10 N (2.24 lbs.) maximum
Withdrawal force between jacks and plugs	0.9 N (0.20 lbs.) minimum
Materials	Bodies and nuts: Brass. Inner male contact: Brass or Beryllium Copper. Inner and outer female contacts: Beryllium Copper. Insulators : PTFE or Thermoplastics. Crimp ferrules: Copper alloy
Finish/Plating	Contact surfaces: Gold over Nickel. Bodies and crimp ferrules: Nickel or Gold over Nickel.

Environmental

Temperature Rating	-40° C to 85°C
--------------------	----------------

General

Connector Durability Standards	500 matings minimum CECC 22230, DIN 47297, RC9333 (T54 only)
--------------------------------	---

Cannon 75 Ohm Connectors

1.0/2.3

1.0/2.3 Straight Plug

Part Number	Cable Type
D55-F24-3022GDA	ST212 / CT1320/735A (alt)
D55-F24-3024GDA	ST214
D55-F24-3033GDA	BT2003
D55-F24-3035GDA	BT3002/TZC75024
D55-F24-3037GDA	RA7000
D55-F24-3038GDA	RA8000
D55-F24-3049GDA	734A
D55-F24-3050GDA	735A
D55-F24-3052GDA	0.4/2.42/4.07
D55-F24-3069GDA	1855A / SDV-LFH
D55-F24-3079GDA	RG179B/U

Assembly Instructions: BBAI 1269

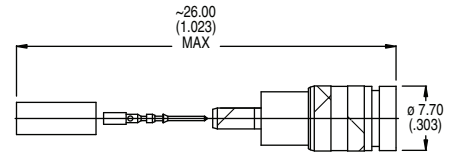

1.0/2.3 HD (High Density) Plug

Part Number	Cable Type
D55-F24-3922GDA	ST212/CT1320/735A (alt)
D55-F24-3935GDA	BT3002/TZC75024
D55-F24-3950GDA	735A
D55-F24-3979GDA	RG-179B/U

Assembly Instructions: BBAI 1269

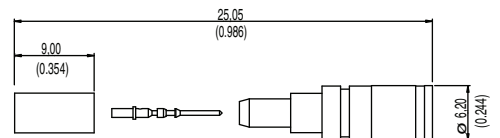

1.0/2.3 Straight Bulkhead Jack

Part Number	Cable Type
D55-F27-3035GEA	BT3002/TZC75024
D55-F27-3079GEA	RG179B/U

Assembly Instructions: BBAI 1281

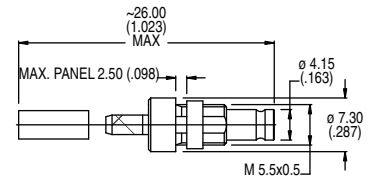

1.0/2.3 Right Angle Plug

Part Number	Cable Type
D55-F28-3233A9A	BT2003
D55-F28-3235A9A	BT3002/TZC75024
D55-F28-3236A9A	BT5000
D55-F28-3237A9A	RA7000
D55-F28-3050A9A	735A

Assembly Instructions: BBAI 1041

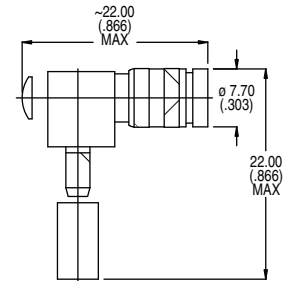

Contact Customer Service for other cable types

1.0/2.3 Straight PCB Mount Jack

Part Number
D51-F51-9002GBA

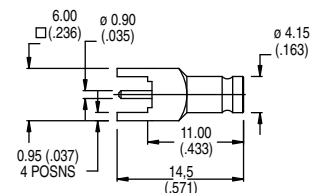

Dimensions shown in mm (inch)
Specifications and dimensions subject to change

www.ittcannon.com

Cannon 75 Ohm Connectors

Type 54 (1.0/2.3)

1.0/2.3 Straight PCB Mount Bulkhead Jack

Part Number

D51-F51-9006GBA (with lock nut)

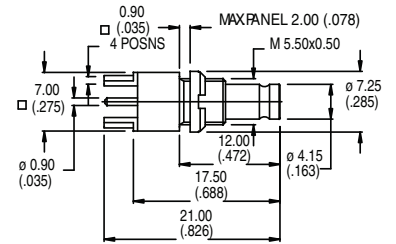

1.0/2.3 Right Angle PCB Mount Bulkhead Jacks

Part Number

D51-F53-9015GBA

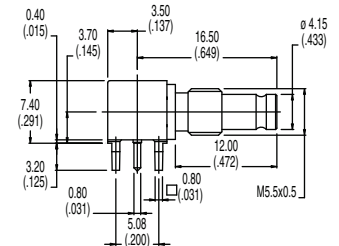

D51-F53-9018GBA (with Lock nut)

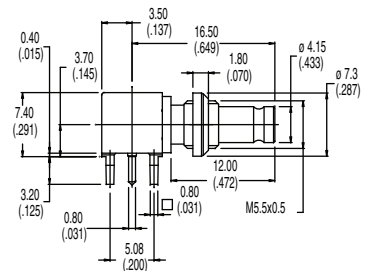

051-F53-9059EAA

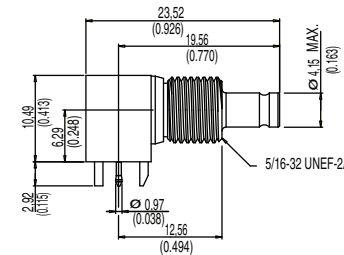

B0023382 Panel Mounting Hardware Kit
(Spacer, Washer, Lockwasher, Lock Nut)

Type 54 Straight Plug

Part Number	Cable Type	Industry
D55-F24-3133GDA	BT2003	Plug 54/3B
D55-F24-3135GDA	BT3002/TZC75024	Plug 54/5B
D55-F24-3136GDA	BT5000	Plug 54/6B
D55-F24-3137GDA	RA7000	Plug 54/7B
D55-F24-3138GDA	RA8000	Plug 54/8B

Assembly Instructions: BBAI 1265

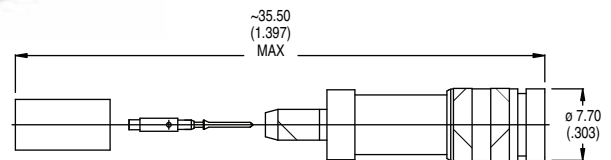

Type 54 Right Angle Plug

Part Number	Cable Type	Industry Reference
D55-F28-3233A9A	BT2003	Plug 54/3A
D55-F28-3235A9A	BT3002/TZC75024	Plug 54/5A
D55-F28-3236A9A	BT5000	Plug 54/6A
D55-F28-3237A9A	RA7000	Plug 54/7A
D55-F28-3238A9A	RA8000	Plug 54/8A

Assembly Instructions: BBAI 1041

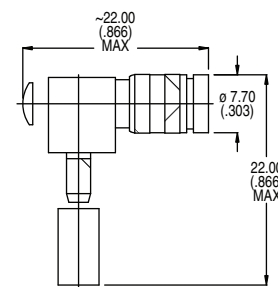

Dimensions shown in mm (inch)
Specifications and dimensions subject to change

www.ittcannon.com



Cannon 75 Ohm Connectors

Telecom Baluns

ITT's telecom baluns, for use in ITU G.703 applications, converts between a 120 ohm twisted pair and a 75 ohm coaxial transmission line.

These balun connectors have the transformer built into the body, and can be quickly connected to screened or unscreened twisted pair cables through IDC terminations, using a simple assembly tool. The small size allows these connectors to be mounted on a pitch of 10mm.

The balun is ideal for use where it is necessary to interconnect equipment with 75 ohm coaxial outputs to a 120 ohm cable distribution system. The balun is only a little larger than the connector that it would replace.



Features and Benefits

IDC termination	Small size	RoHS 5 Compliant
Quick and simple termination procedure	Meets G.703 standards	

Specifications

Nominal Impedance	Coaxial 75 ohm Twisted pair 120 ohm	
Frequency Range	50 kHz - 10 MHz	
Return loss 75 ohm and 120 ohm	51 - 102 kHz	>18dB
	102 - 2048 kHz	>25dB
	2048 - 3072 kHz	>23dB
	3072 - 10000 kHz	>16dB
Wire Size	Conductor 0.5mm copper Insulation 1.4mm	

CIRCUIT DIAGRAM

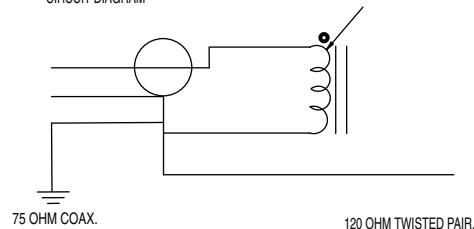

Balun

Part Number
051-127-9989A9G
Type 43 (SMZ) Plug Balun



051-127-9999A9G
HDC 43 (SMZ) Plug Balun



055-F24-9019A9G
1.0/2.3 Push-Pull Plug Balun



Assembly Instructions: BBAI 1240

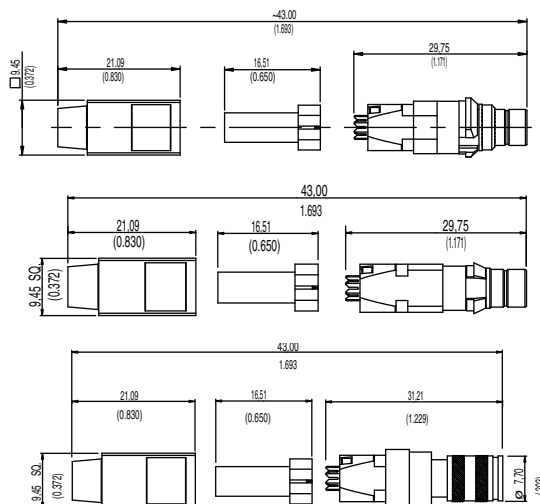

Contact Customer Service if the style you require is not listed.



Dimensions shown in mm (inch)
Specifications and dimensions subject to change

www.ittcannon.com

QT-BNC

This innovative termination technique provides the QT-BNC with a high pressure, gas tight center conductor joint of exceptional mechanical integrity, without crimping the center contact. The QT-BNC is a 75 ohm pre-assembled connector with an integral central contact and rear crimp ferrule. This connector may be terminated onto cable in under 20 seconds, significantly reducing installation costs.



Applications

- Central Office Switching • Cross Connect Equipment • Telecommunications

Features and Benefits

Designed to simplify field installations with less piece parts

Optional right angle strain relief boot accessory (show above)

Telcordia Audited and Approved

Plastic rear cap is color coded for easy identification of cable type

Compatible with select competitive crimp tools and die sets

3:1 reduction in assembly time than conventional 3 piece crimp BNC plugs

RoHS Compliant Part Numbers



Specifications

Bump	4000 total at 390 m/s ²		
Cable Retention	Cable	Axial Force	Torque
	M17/29-RG59/	133 N (30 lbs) min.	0,9 Nm (8.0 in. lbs)
	734 type	311 N (70 lbs) min.	0,9 Nm (8.0 in. lbs)
	735A type	111 N (25 lbs) min.	0,45 Nm (4.0 in. lbs)
	BT3002	111 N (25 lbs) min.	0,45 Nm (4.0 in. lbs)
Connector Durability	500 mating cycles min.		
Contact Current Rating	1.5 A dc max.		
Contact/Insulator Retention	22,3 N (5 lbs) min. axial force		
Contact Resistance	Outer contact: 1.0 mΩ max.; Braid to body: 1.0 mΩ max.		
Corona Level	375 V ac rms min. at 21 km (70,000 ft)		
Coupling Mechanism Retention	445 N (100 lbs) min.		
DWV	1500 V ac rms at sea level		
Frequency Range	DC to 2.0 GHz		
Impedance	75Ω nominal		
Insertion Force	22,3 N (5 lbs) max.		
Insertion Loss	0.2 dB max. at 2 GHz		
Insulation Resistance	5000 MΩ min.		
Operating Temperature	-40°C to 85°C (-40°F to 185°F)		
Operating Voltage	500 V ac rms at sea level		
RF Leakage	-60 dB typical up to 2 GHz		
Shock	490 m/s ² for 11 ms		
Termination Resistance (QT Center contact)	3 mΩ max. (excluding pole resistance)		
Vibration	(a) Frequency range from 10 Hz to 500 Hz. (b) Displacement: 0.75 (.029), (c) Acceleration: 98 m/s ² , (d) Duration: 6 hours.		
VSWR	1.2 max. (DC to 1 GHz); 1.3 max. (1 to 2 GHz)		

Description	Material	Finish
Connector Body	Phosphor bronze	3.5 μM (140 μ in.) Nickel
Insulators	Polymers rated to UL 94V-0	—
Center Contact Male	Beryllium copper	1.27 μM (50 μ in.) Gold
Coupling Nut	Die Cast, Copper Zinc Alloy	2.0 μM (80 μ in.) Nickel
Crimp Ferrule	Annealed Copper Alloy	3.8 μM (150 μ in.) Nickel
Spring	Stainless Steel	—

Dimensions shown in mm (inch)

Specifications and dimensions subject to change

www.ittcannon.com

Cannon 75 Ohm Connectors

QT-BNC

QT BNC Plug

Part Number	Cap Color	Cable Type
W58-124-9019910	Red	735A
W58-124-901991A	Red	735A
W58-124-9019916	Red	735A
W58-124-9039910	Yellow	RG59B
W58-124-9039916	Yellow	RG59B
W58-124-9069910	Blue	734
W58-124-9069916	Blue	734
W58-124-908991A	White	BT3002 / TZC75024
W58-124-919991A	Red	0.4/2.42/4.07
W58-124-901991S	Red	735A
W58-124-901991R	Red	735A
33533-47-010006		735A

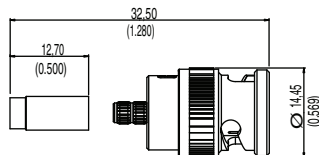

QT-BNC w/Boot
 QT-BNC w/Boot
 RTA Boot Only for 735A

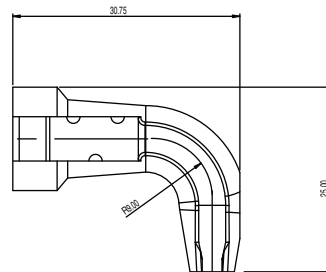
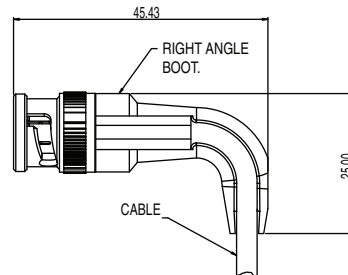

Assembly Instructions:

BBAI 1243 (RG-59)
 BBAI 1262 (735, 734)
 BBAI 1268 (BT 3002, TCZ75024)

Mating Interface

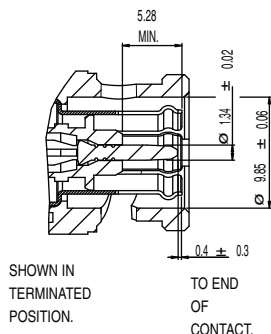

Tooling Accessories:

Dual Action QT-BNC Hand Crimp Tool
 QT-BNC Pneumatic Crimp Tool
 Powered Coaxial Cable Strip Tools and Cutter Heads

Please refer to the Tooling section pages 22-25 for part numbers.

Last digit in p/n signifies packaging type:

- 0 = single bag
- A = 25 pc tray
- 6 = 100 pc bag
- S = single
- R = 100 pc bag
- RTA Boot = 1000 pc bag



Dimensions shown in mm (inch)
 Specifications and dimensions subject to change

www.ittcannon.com

1.6/5.6

The Cannon range of 1.6/5.6 connectors are suitable for use in 75 ohm communication systems and have become the recognized standard in telecommunications in many parts of the world.

Designed around the requirements of DIN 47295, CECC 22240 and IEC 169-13, these connectors are designed for field installation and feature threaded couplings to ensure mating integrity and a snap-on interface for ease of connection.

The range of parts shown in this publication includes plug and jack connectors for a variety of cables. Other cable types and connector styles may be available on request.



Applications

- Switching Equipment • DSX Cross Connects • Base Stations • Routers • Wireless • Telecom • LAN Equipment

Features and Benefits

Threaded coupling mechanism to ensure secure connection and snap-on interface for ease of engagement and separation

Three-part construction with crimp inner contact and outer ferrule (no soldering required)

Designed for the most commonly used telecom cables in North America and Europe

Most installations require no special tooling

Designed for field installation

RoHS Compliant Part Numbers



Mating Interfaces

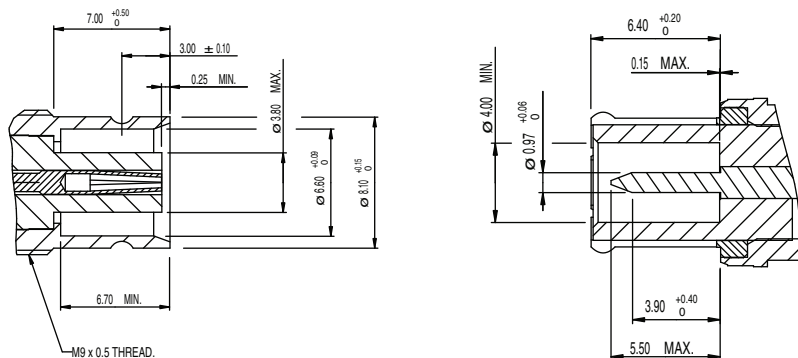

Dimensions shown in mm (inch)
Specifications and dimensions subject to change

www.ittcannon.com



Cannon 75 Ohm Connectors

DIN1.6/5.6

ELECTRICAL	Impedance	75 Ω nominal	
	Frequency Range	0-1 GHz	
	Voltage Rating*	At sea level =330 Vrms	
	Insulation Resistance	10G Ω minimum	
	Contact Resistance	Inner contact = 4 m Ω maximum Outer contact: 2 m Ω maximum	
	Reflection Coefficient*	With f = 0.1 GHz	= 0.02 maximum
		With f = 0.1-0.5 GHz	= 0.04 maximum
With f = 0.5-1.0 GHz		= 0.10 maximum	
MECHANICAL			
Withdrawal force inner female contact	0.5N (0.11 lbs) minimum		
Withdrawal force inner male contact	1.7N (0.38 lbs) minimum		
Insertion force between jacks and plugs	Screw types: 12N (2.7 lbs) maximum. Push-pull type: 20N (4.5 lbs) maximum		
Withdrawal force between jacks and plugs	Screw types: 22N (4.9 lbs) minimum. Push-pull type: 20N (4.5 lbs) maximum		
	Materials	Body and nuts: Brass. Inner male contact: Brass Inner ferrule contact and outer male contact: Beryllium copper. Insulators: PTFE Crimp ferrules: Annealed copper alloy.	
	Finish/Plating	Contact surfaces: Gold over nickel. Female bodies: Gold over nickel. Male bodies: Nickel or silver. Nuts and crimp ferrules: Nickel	
ENVIRONMENTAL	Temperature	-40°C to 85°C	
GENERAL	Connector Durability	500 matings minimum	
	Standards	CECC 22240, DIN 47295, IEC 169-13	

*Guideline value only - will depend on cable and connector types



DIN1.6/5.6

1.6/5.6 Straight Plug

Part Number	Cable Type
D50-A24-3033GDA	BT2003
D50-A24-3035GDA	BT3002/TZC75024
D50-A24-3037GDA	RA7000

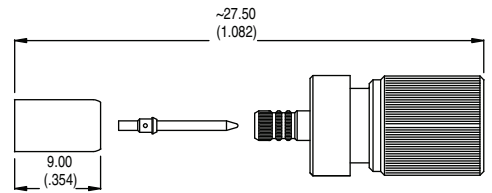

Assembly Instructions: BBAI 1245

1.6/5.6 Straight Bulkhead Jack

D50-A27-3033GEA	BT2003
D50-A27-3035GEA	BT3002/TZC75024
D50-A27-3037GEA	RA7000

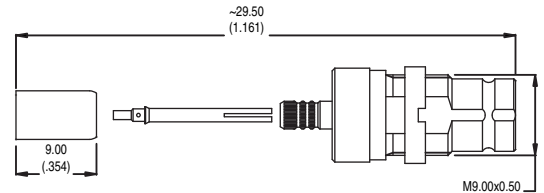

Assembly Instructions: BBAI 1245

1.6/5.6 Right Angle Plug

D50-A28-3133GKA	BT2003
D50-A28-3135GKA	BT3002/TZC75024
D50-A28-3137GKA	RA7000

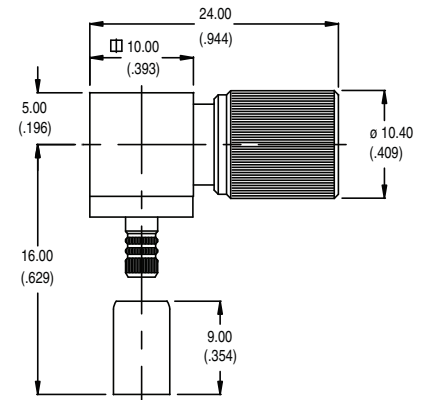

Assembly Instructions: BBAI 1247

1.6/5.6 Right Angle Bulkhead Jack

D50-A30-3233GBA	BT2003
D50-A30-3235GBA	BT3002/TZC75024
D50-A30-3237GBA	RA7000

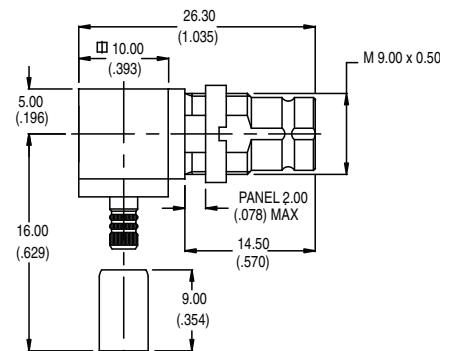

Assembly Instructions: BBAI 1247

Contact Customer Service for other cable types

Dimensions shown in mm (inch)
Specifications and dimensions subject to change

www.ittcannon.com



Cannon 75 Ohm Connectors

Tooling

Ferrule Crimp tools

T1025

Crimp tool frame only



Ferrule Crimp Tool Die Sets for T1025

T1025/5

Hex Die 4.52mm (.178) A/F

T1025/8

Hex Die 6.81mm (.268) A/F

T1025/9

Hex Die 3.84mm (.151) A/F

T1025/10

Hex Die 5.41mm (.213) A/F

T1025/36

Hex Die 4.3mm (.169) A/F

K26293

3 Way Hex Die, 2.67mm (.105), 3.25mm (.128), 4.52mm (.178) A/F



Note; Contact Customer Service for availability on other die sets

Ferrule Crimp Tool

050-000-0020210

Crimp tool frame only



Ferrule Crimp Tool Die Sets for 050-000-0020210

050-000-0020010

Die set 3.25mm (.128) and 5.41mm (.213) A/F

050-000-0020011

Die set 3.84mm (.151) and 5.18mm (.204) A/F

050-000-0020012

Die set 4.52mm (.178) and 6.48mm (.255) A/F



Note; Contact Customer Service for availability on other die sets

Center Contact Crimp Tools

050-000-0030070

12 point center pin indent AFMSP-76

T4519

8 point center pin indent crimp tool MH800 GB109



Center Contact Crimp Tool without Positioner

995-0001-584

8 point center pin indent crimp tool M22520/2-01



Center Contact Positioner for 995-0001-584

T4831

Positioner for 1.6/5.6 contacts

T4868

Positioner for BNC contacts

T4852

Positioner for 1.0/2.3 contacts



Dimensions shown in mm (inch)
Specifications and dimensions subject to change

www.ittcannon.com

Tooling

Insertion / Extraction Tools for 1.0/2.3 and Type 54 Connectors

T4839	Straight tool, length 190mm (7.48) (figure A)
T4889	Straight and Right Angle Tool, length 190mm (7.48) (figure B)
T4902	Straight and Right Angle Tool, length 430mm (16.9) (figure B)

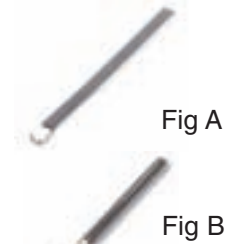

DDF Plug Extraction Tools

T4653	Type 43 Extractor Tool 65A
T4825	HDC43 Extractor Tool



Balun Termination Tools

T4836	Type 43 Plug Balun, 1.0/2.3 Plug Balun
T4837	HDC 43 Plug Balun



Lock Nut Assembly Tools

T4882	To be used with 1.0/2.3 connectors
T4840	To be used with 1.6/5.6 connectors



QT-BNC Crimp Tools

050-000-0030210	QT-BNC Dual Action Crimp Frame Only
050-000-0030120	QT-BNC Dual Action Crimp Tool Frame w/ .178 hex die
050-000-0030150	QT-BNC Dual Action Crimp Tool Frame w/.255 hex die



QT-BNC Die Sets

050-000-0030122	.178 Hex Die for QT-BNC
050-000-0030152	.255 hex die for QT-BNC



QT-BNC Complete Crimp Tool Kit (with case)

050-000-003200S	Contents include; carry case, 734 & 735 die sets, crimp tool frame, hand held coax stripper and spare pockets for QT-BNC connectors
-----------------	---



Calibration Tools (go/no go gauge) for QT-BNC Die Sets

050-000-0030023	.178 hex
050-000-0030043	.255 hex



Cannon 75 Ohm Connectors

Tooling

QT-BNC Pneumatic Crimp Machine

050-000-0040020	Pneumatic crimp machine with .178 die set for 735 type cables
050-000-0040040	Pneumatic crimp machine with .255 die set for 734, RG-59 type cables



QT-BNC Pneumatic Die Sets

050-000-0040022	.178 Hex Die for 735 type cables
050-000-0040042	.255 Hex Die for 734, RG-59 type cables



Powered Coax Stripper, ITT Port-a-Strip Kit (with case)

T0K-000-0000	Contents include; carry case, 734, RG-59 cutting head, power hand driver, rechargeable battery, recharging cord
T0K-000-0001	Contents include; carry case, 735 cutting head, power hand driver, rechargeable battery, recharging cord
T0K-000-0004	Contents include; carry case, 1855 cutting head, power hand driver, rechargeable battery, recharging cord



Contact Customer Service for availability on kits for other cable types.

Replacement Cutting Heads for Powered Coax Stripper

T00-000-0000	734, RG-59 Cutting head
T00-000-0001	735 Cutting head
T00-000-0009	1855 Cutting head
T00-000-0010	BT3002
T00-000-0011	RA7000
T00-000-0012	RA8000



Contact Customer Service for availability on other cable types.

Complete Powered Coax Stripper, ITT Port-a-Strip Kit (with case)

T0K-000-0002	Contents include; carry case, 734 cutting head, 735 cutting head, power hand driver, rechargeable battery, recharging cord, AC, DC power supply
--------------	---

Contact Customer Service for availability on kits for other cable types.



Power Coax Stripper Accessories

TPS-000-0000	AC/DC Power Supply (figure A)
TSB-000-0000	Spare rechargeable battery with recharging cord (figure B)
TCC-000-0000	Coax cable cutter (figure C)



(figure A)



(figure B)



(figure C)



Dimensions shown in mm (inch)
Specifications and dimensions subject to change

www.ittcannon.com

Tooling

Bench-Top Powered Coax Stripper

T0B-000-0000 Designed for high volume coax cable prepping, foot pedal operated.
Cutter heads sold separately.



Cutting Heads for Bench-Top Powered Coax Stripper

TBC-000-0000 Bench top cutting head for 734, RG-59 cable
TBC-000-0001 Bench top cutting head for 735 cable
TBC-000-0006 Bench top cutting head for 1855 cable
TBC-000-0007 Bench top cutting head for BT3002 cable
TBC-000-0008 Bench top cutting head for RA7000 cable
TBC-000-0009 Bench top cutting head for RA8000 cable



Contact Customer Service for availability on other types of cables.

Cannon 75 Ohm Connectors

Product Safety Information

THIS NOTE MUST BE READ IN CONJUNCTION WITH THE PRODUCT DATA SHEET/CATALOG. FAILURE TO OBSERVE THE ADVICE IN THIS INFORMATION SHEET AND THE OPERATING CONDITIONS SPECIFIED IN THE PRODUCT DATA SHEET/ CATALOG COULD RESULT IN HAZARDOUS SITUATIONS.

1. MATERIAL CONTENT AND PHYSICAL FORM

Electrical connectors do not usually contain hazardous materials. They contain conducting and non-conducting materials and can be divided into two groups.

a) Printed circuit types and low cost audio types which employ all plastic insulators and casings.

b) Rugged, Fire Barrier and High Reliability types with metal casings and either natural rubber, synthetic rubber, plastic or glass insulating materials. Contact materials vary with type of connector and also application and are usually manufactured from either: Copper, copper alloys, nickel, alumel, chromel or steel. In special applications, other alloys may be specified.

2. FIRE CHARACTERISTICS AND ELECTRIC SHOCK HAZARD

There is no fire hazard when the connector is correctly wired and used within the specified parameters. Incorrect wiring or assembly of the connector or careless use of metal tools or conductive fluids, or transit damage to any of the component parts may cause electric shock or burns. Live circuits must not be broken by separating mated connectors as this may cause arcing, ionization and burning. Heat dissipation is greater at maximum resistance in a circuit. Hot spots may occur when resistance is raised locally by damage, e.g. cracked or deformed contacts, broken strands of wire. Local overheating may also result from the use of the incorrect application tools or from poor quality soldering or slack screw terminals. Overheating may occur if the ratings in the product Data Sheet/Catalog are exceeded and can cause breakdown of insulation and hence electric shock. If heating is allowed to continue it intensifies by further increasing the local resistance through loss of temper of spring contacts, formation of oxide film on contacts and wires and leakage currents through carbonization of insulation and tracking paths. Fire can then result in the presence of combustible materials and this may release noxious fumes. Overheating may not be visually apparent. Burns may result from touching overheated components.

3. HANDLING

Care must be taken to avoid damage to any component parts of electrical connectors during installation and use. Although there are normally no sharp edges, care must be taken when handling certain components to avoid injury to fingers. Electrical connectors may be damaged in transit to the customers, and damage may result in creation of hazards. Products should therefore be examined prior to installation/use and rejected if found to be damaged.

4. DISPOSAL

Incineration of certain materials may release noxious or even toxic fumes.

5. APPLICATION

Connectors with exposed contacts should not be selected for use on the current supply side of an electrical circuit, because an electric shock could result from touching exposed contacts on an unmated connector. Voltages in excess of 30 V ac or 42.5 V dc are potentially hazardous and care should be taken to ensure that such voltages cannot be transmitted in any way to exposed metal parts of the connector body. The connector and wiring should be checked, before making live, to have no damage to metal parts or insulators, no solder blobs, loose strands, conducting lubricants, swarf, or any other undesired conducting particles. Circuit resistance and continuity check should be made to make certain that there are no high resistance joints or spurious conducting paths. Always use the correct application tools as specified in the Data Sheet/Catalog. Do not permit untrained personnel to wire, assemble or tamper with connectors. For operation voltage please see appropriate national regulations.

IMPORTANT GENERAL INFORMATION

(i) Air and creepage paths/Operating voltage. The admissible operating voltages depend on the individual applications and the valid national and other applicable safety regulations.

For this reason the air and creepage path data are only reference values. Observe reduction of air and creepage paths due to PC board and/or harnessing.

(ii) Temperature

All information given are temperature limits. The operation temperature depends on the individual application.

(iii) Other important information

Cannon continuously endeavors to improve their products. Therefore, Cannon products may deviate from the description, technical data and shape as shown in this catalog and data sheets.

“Engineered for life” is a registered trademark of ITT Corporation ©2007. All other trademarks or registered trademarks are property of their respective owners. All data subject to change without notice.

Product Warranty

ITT Electronic Components, a Division of ITT Corporation manufactures the highest quality products available in the marketplace; however these products are intended to be used in accordance with the specifications in this publication. Any use or application that deviates from the stated operating specifications is not recommended and may be unsafe. No information and data contained in this publication shall be construed to create any liability on the part of Cannon. Any new issue of this publication shall automatically invalidate and supersede any and all previous issues. A limited warranty applies to Cannon products. Except for obligations assumed by Cannon under this warranty, Cannon shall not be liable for any loss, damage, cost of repairs, incidental or consequential damages of any kind, whether or not based on express or implied warranty, contract, negligence or strict liability arising in connection with the design, manufacture, sale, use or repair of the products. Product availability, prices and delivery dates are exclusively subject to our respective order confirmation form; the same applies to orders based on development samples delivered. This publication is not to be construed as an offer. It is intended merely as an invitation to make an offer. By this publication, Cannon does not assume responsibility or any liability for any patent infringements or other rights of third parties which may result from its use. Reprinting this publication is generally permitted, indicating the source. However, Cannon's prior consent must be obtained in all cases.



Rack & Panel Connectors

ITT is the world leader in rack and panel connectors, offering unmatched variety of shell configurations and insert arrangements, materials, plating and contact options. Many of our standard and custom designs meet the stringent requirements of ARINC 600, ARINC 404 (MIL-C-81659), and MIL-DTL-83733 standards.



www.ittcannon.com/rackandpanel

Circular/Filter/Hermetic Connectors

As a world leader in circular, filter and hermetic connectors, ITT can leverage its design and manufacturing expertise to fit virtually any application. Our expertise includes fast positive mating for a wide range of military applications, as well as numerous sizes and contact configuration for various harsh environments. ITT can also meet numerous specs, including NATO and MIL standards.



www.ittcannon.com/circulars • www.ittcannon.com/filter • www.ittcannon.com/hermetics

D-Subminiature Connectors

Cannon invented D-sub connectors in 1952. Our family of D-Subs now includes combinations of signal, power and RF, as well as severe service sealed connectors. Cannon D-Subs are available with an extensive line of backshells and accessories and are one of the most economical shielded connector solutions available. Qualified to the MIL-DTL-24308 specification.



www.ittcannon.com/dsubs

Fiber Optic Connectors and Cable Assemblies

Cannon fiber optic solutions provide an excellent performance/cost value. Performance can be tailored to the end system, and our use of superior materials and bonding agents provides highly effective solutions. Our wide variety of products includes fiber optic hybrid contacts, multi-channel, rack and panel, and hi-rel assemblies, including MIL and ARINC standard solutions.



www.ittcannon.com/fiberoptics

Microminiature Connectors

Cannon microminiature connectors offer high performance and reliability with exceptional versatility. Available in rectangular, circular and strip configurations for countless applications, many of our connectors meet or exceed applicable requirements of the MIL-DTL-83513 specification.



www.ittcannon.com/micro

ITT's Electronic Components business (www.ittcannon.com) is an international supplier of connectors, interconnects, cable assemblies, I/O card kits and smart card systems. As a worldwide leader in connector technology for nearly a century, ITT offers one of the industry's broadest product offerings, manufacturing capability worldwide, fast time to market, high volume/high yield capacity, robust design and Value-Based Product Development and an extensive sales and customer support network.





ITT

75 Ohm Connectors Customer Support Locations

AMERICAS

100 New Wood Road
Watertown, CT 06796
Tel: 860.945.0206
Toll Free: 800.683.7666
Fax: 860.645.0303

ASIA

Unit 901 & 912, West Tower,
Shun Tak Center
168-200 Connaught Road
Central, Hong Kong
Tel: +852.2732.2720
Fax: +852.2732.2919

EUROPE

Jays Close, Viables Estate
Basingstoke, Hants, RG22 4BA
Tel: +44.1256.311200
Fax: +44.1256.323356